

IREO

INTERIOR - PUBLIC SPACE

SECTION 8

Residence Tower Identification

Template Render

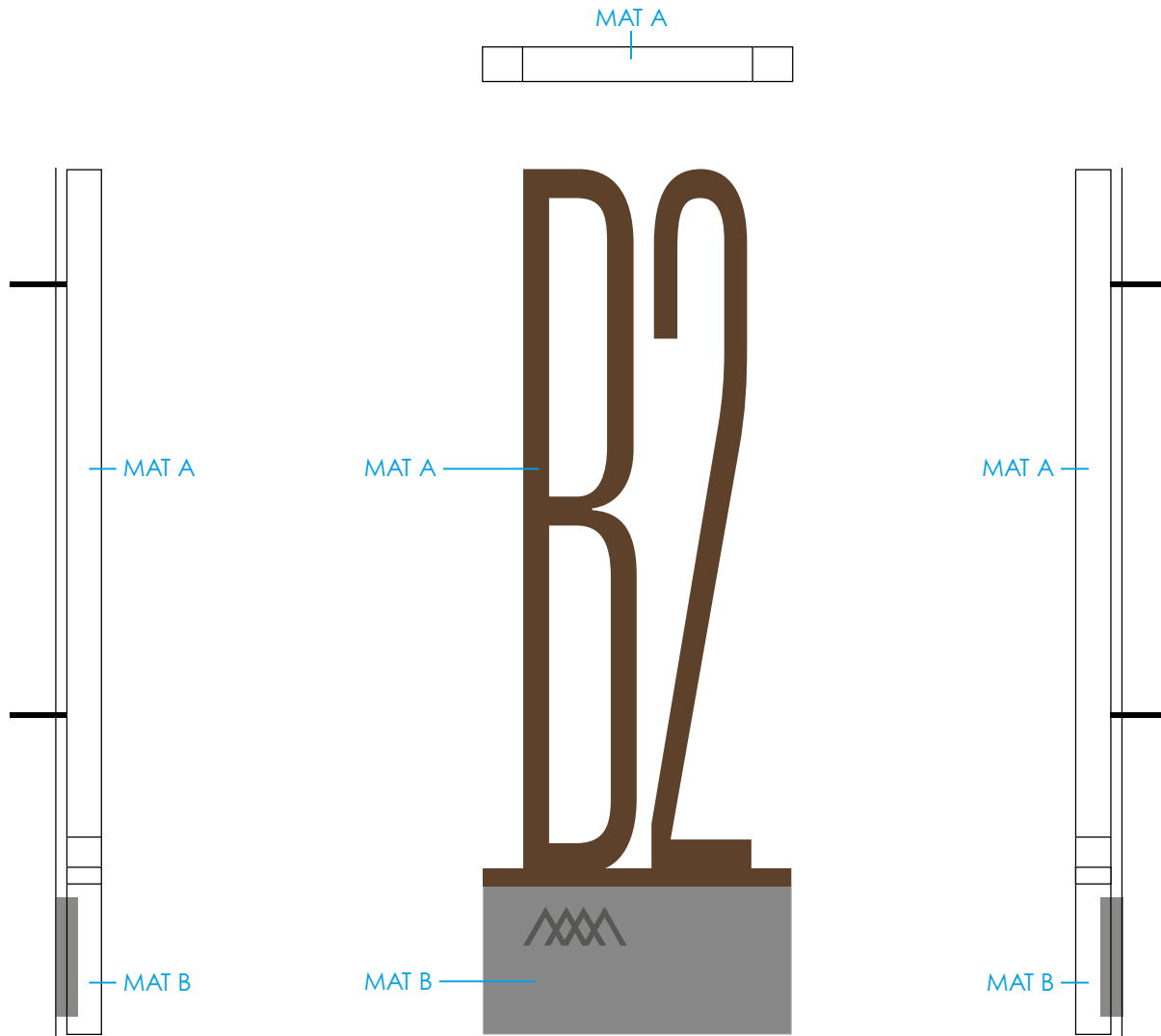

PRIMARY MATERIAL PALETTE

Honed & flamed granite capping sections.

Text – uncoated bare brass.

Front & back capping plates, bare brass.

Granite base – sharea grey.

MAT Code	MAT Options
MAT A (Lettering)	Brass - Primary Stainless Steel - Secondary Powder Coated - Secondary
MAT B (Panel)	Stone - Primary Acm Aluminium - Secondary

Residence Tower Identification

Elevation and Detail

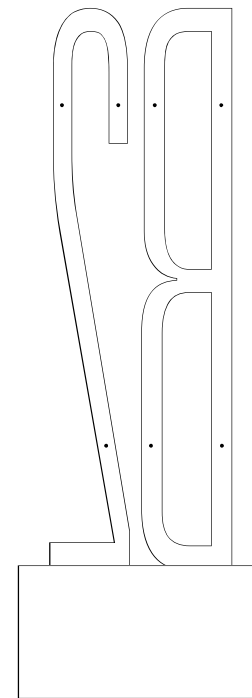
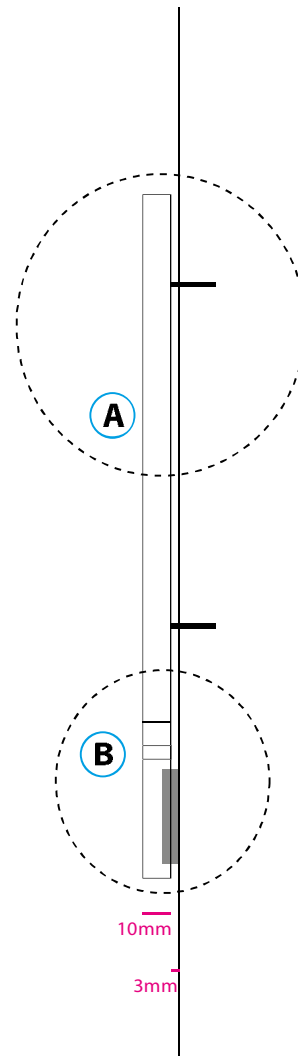
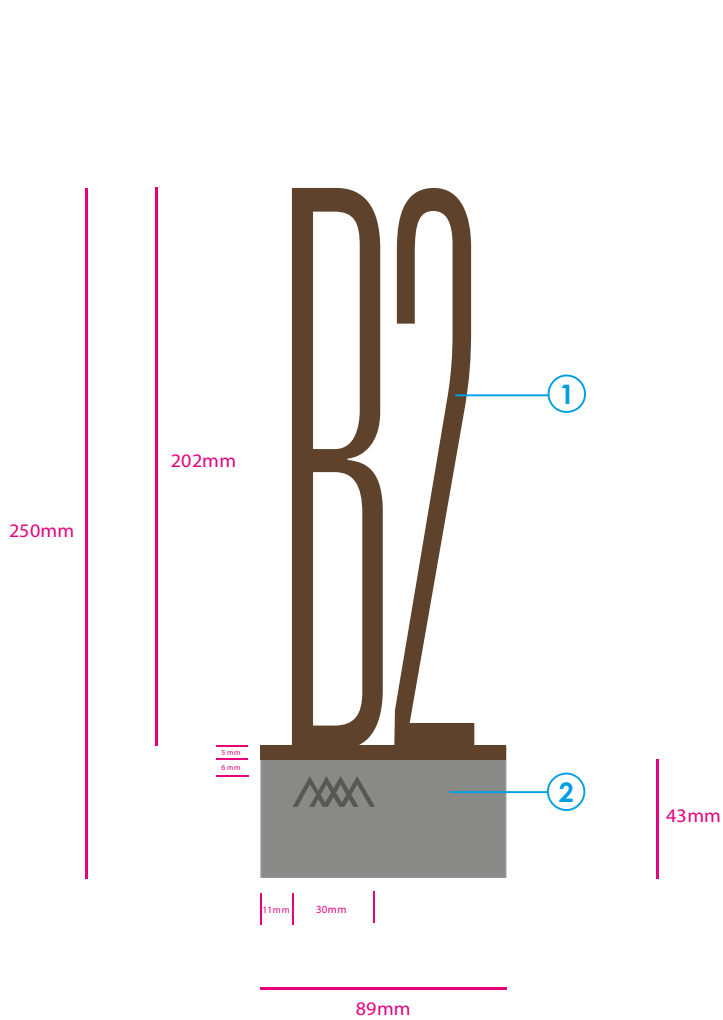

Individual Tower Entrance identification to be wall mounted at individual tower entrances, lift lobby location.

1) One piece laser cut section from 10mm uncoated bare brass. All edges and corners smoothed. Natural oxidization. Pin and silicon fastened to wall with 03mm backspace.

2) Decorative base plate formed from honed granite Shaera Grey. Pin and silicon fastened to wall. Logo icon deep 'V' sandblasted to front face, natural finish, no in fill.

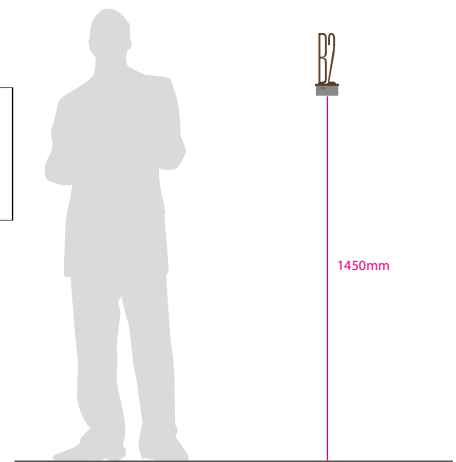

Residence Tower Identification

Detail

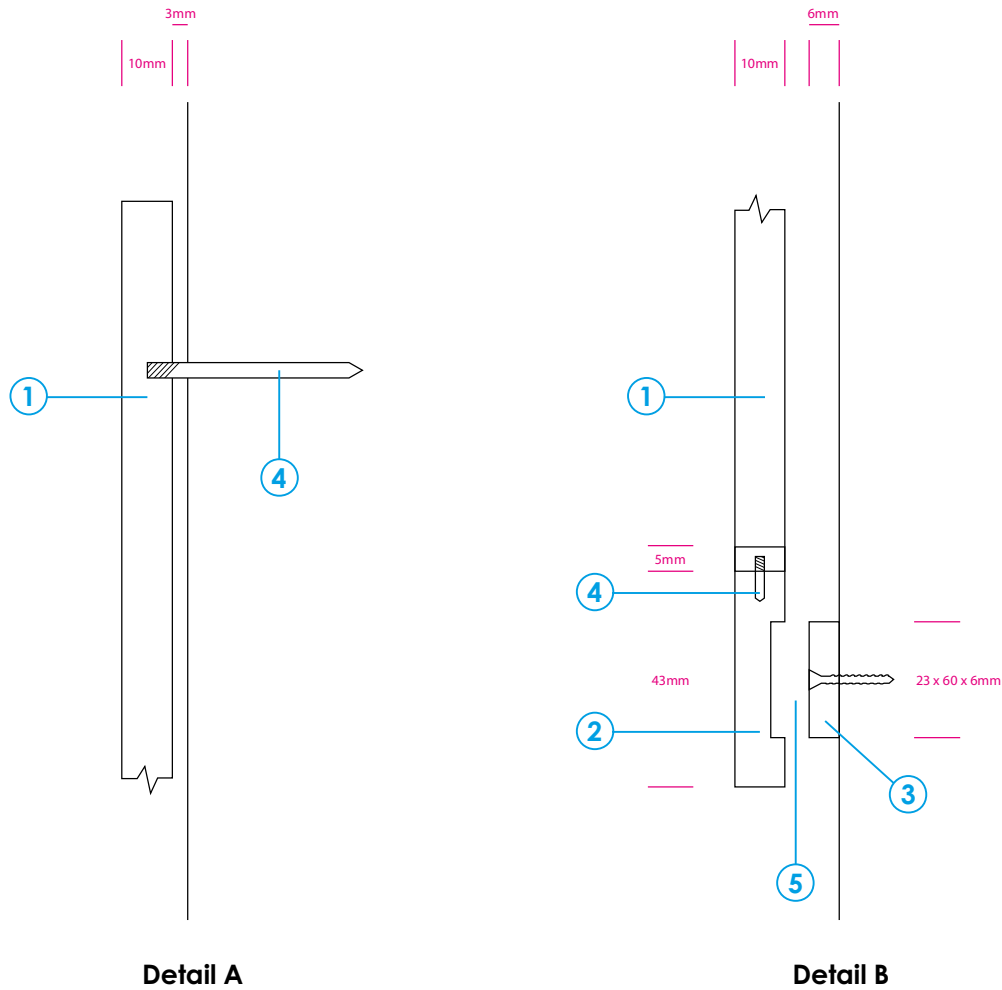

- 1) 1x piece laser cut uncoated bare brass.
- 2) Decorative base plate - Shared Grey - honed.
- 3) Black acrylic wall mounted backer spacer. S/S screw fasteners. Flamed edges.
- 4) Ø3mm solid brass locating/mounting pins screw taped into brass section 1. Liquid bonded into wall and granite section as required.
- 5) Liquid bonded connection between sections 2/3.

Apartment Identification

Render



MATERIAL PALETTE

1.5mm 316L stainless steel,
single brush satin finish.

Apartment Identification

Elevation and Detail

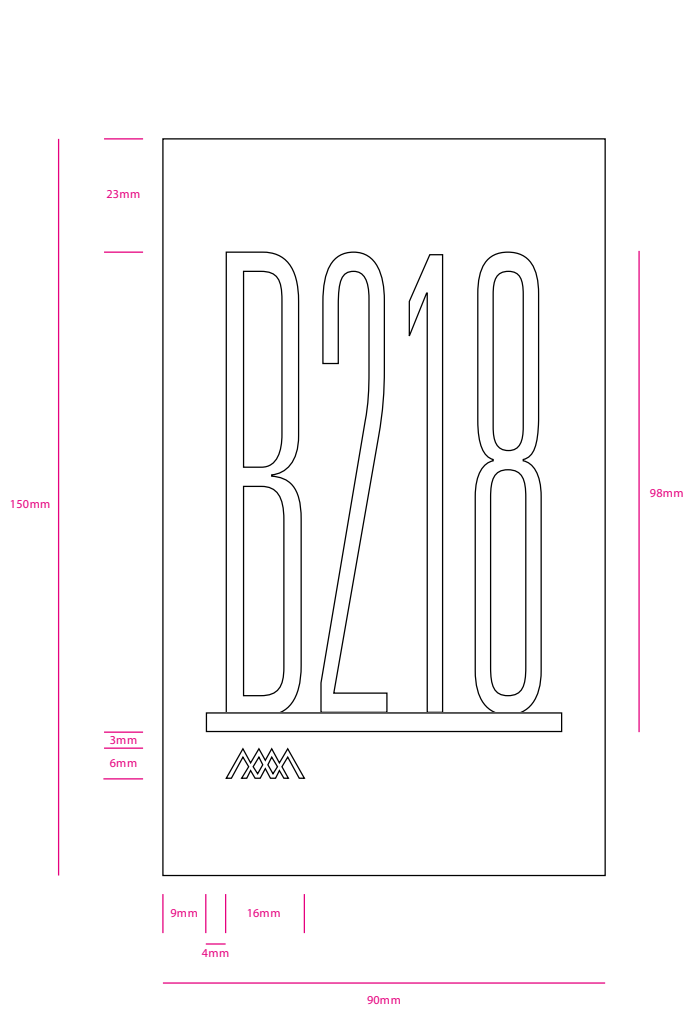

2mm

1) One piece 02mm uncoated bare brass. All edges and corners smooth. Plate tape bonded to sub surface.

2) Logo text & crest chemically etched 0.75mm to front face, natural finish, no in fill.

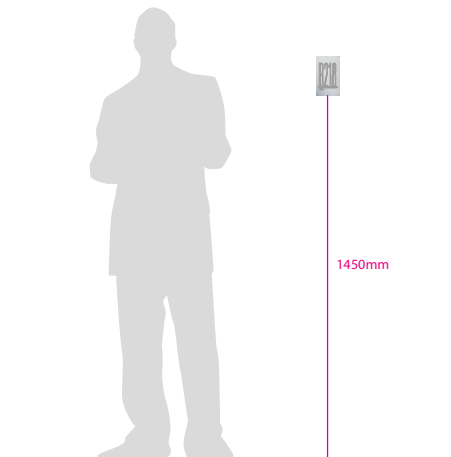

Directional

Render

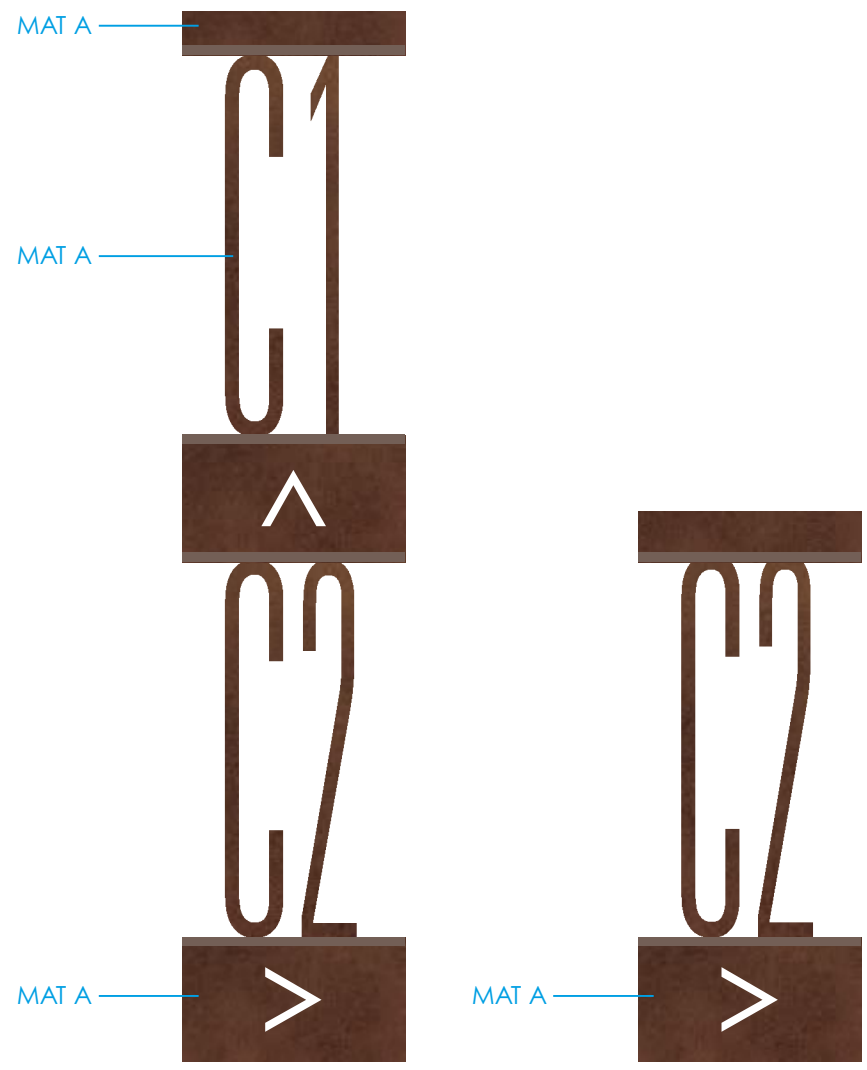

PRIMARY MATERIAL PALETTE

MAT Code	MAT Options
MAT A	Brass - Primary Stainless Steel - Secondary Powder Coated - Secondary

Directional

Elevation and Detail

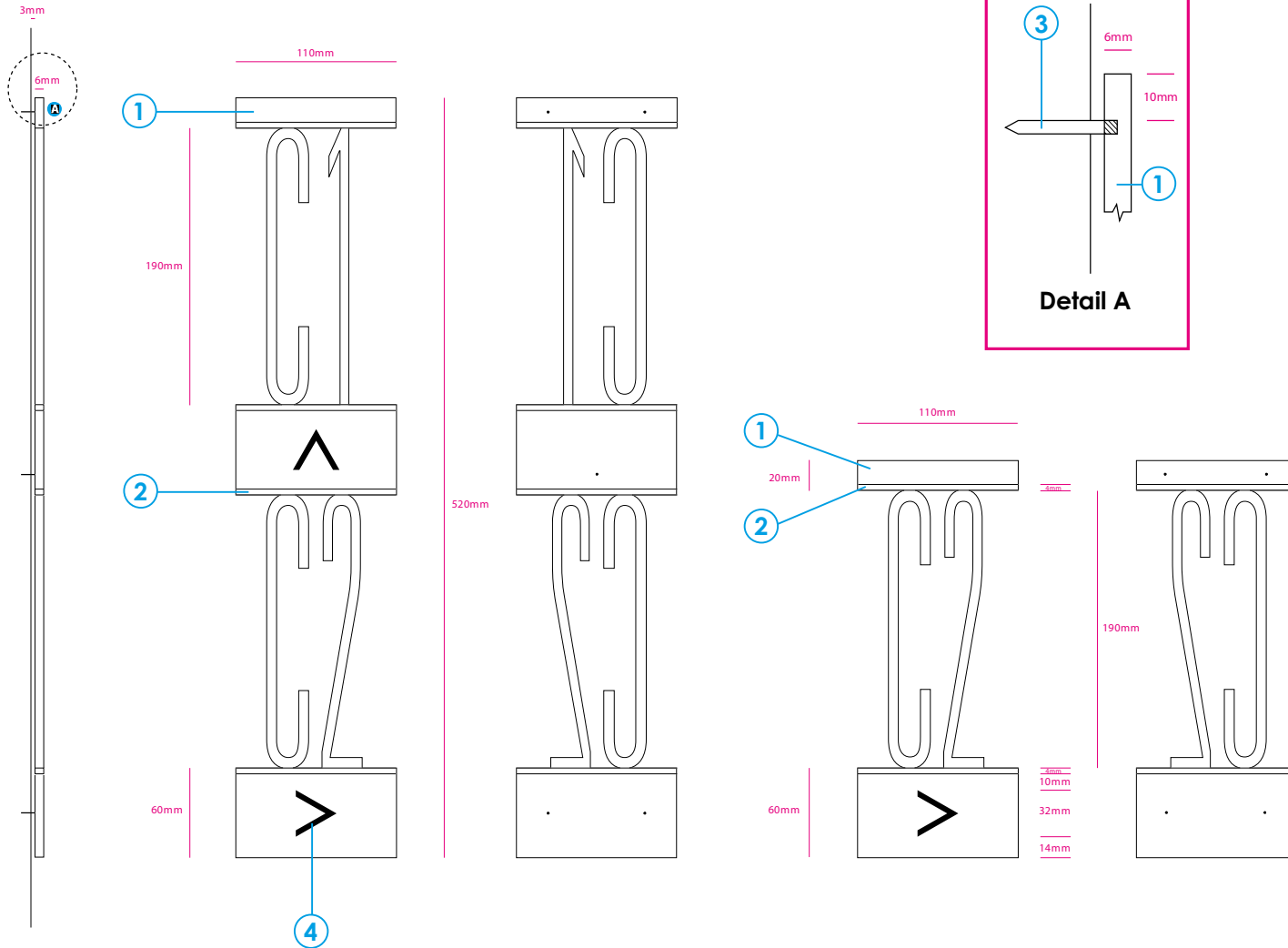

- 1) One piece 06mm laser cut uncoated bare brass sections. All edges and corners smoothed.
- 2) Horizontal bands 01mm surface routed, no in fill.
- 3) 03mm solid brass locating/mounting pin screw taped into brass section 1. Liquid bonded into wall.
- 4) Arrow heads through cut.

PRIMARY MATERIAL PALETTE

Uncoated bare brass.

MAT Code	MAT Options
MAT A	Brass - Primary Stainless Steel - Secondary Powder Coated - Secondary

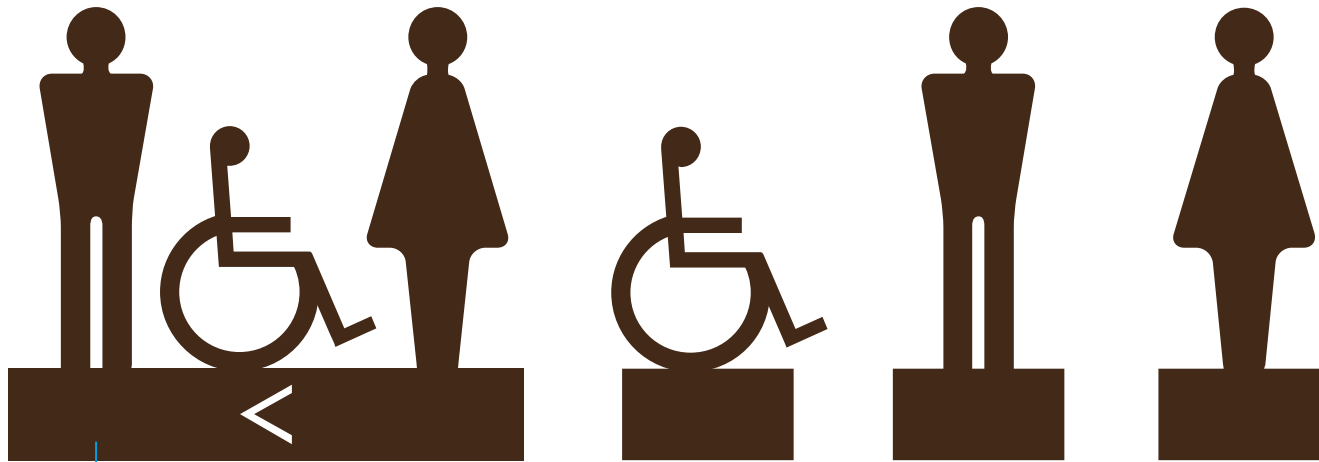

MAT A

Directional - Restroom

Elevation and Detail

- 1) One piece 04mm uncoated bare brass, laser cut. Smoothed all edges.
- 2) Arrowhead through cut.
- 3) 03mm solid brass locating/mounting pins screw taped into brass section 1. Liquid bonded into wall and granite section as required.

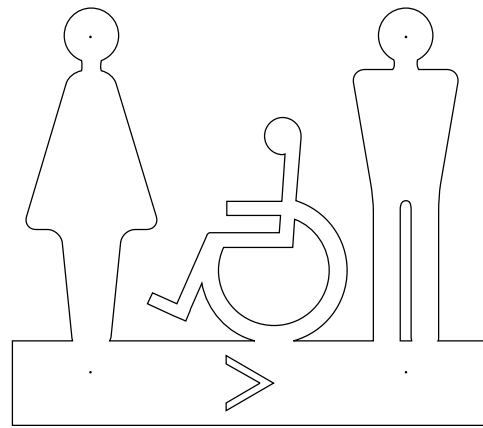
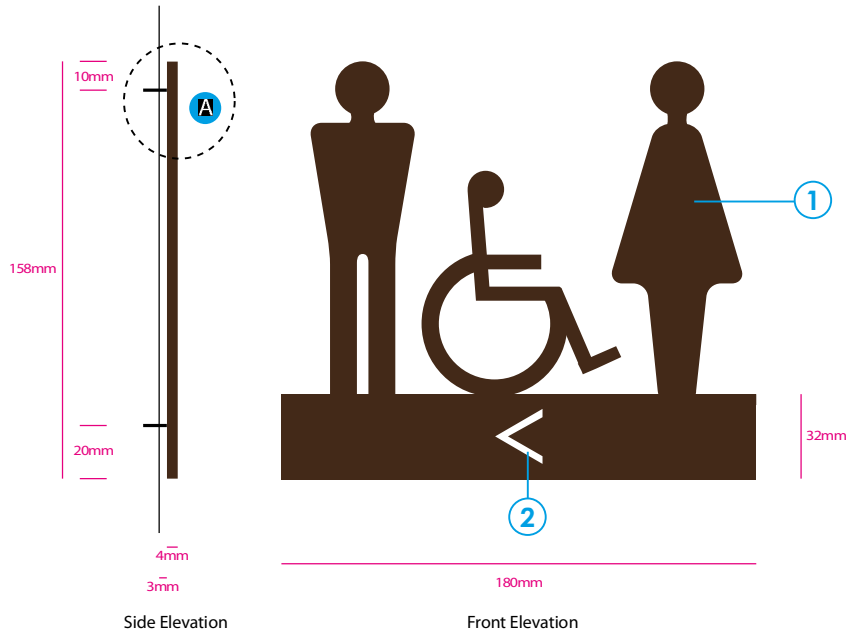

Reverse Face Mounting Pin Locations

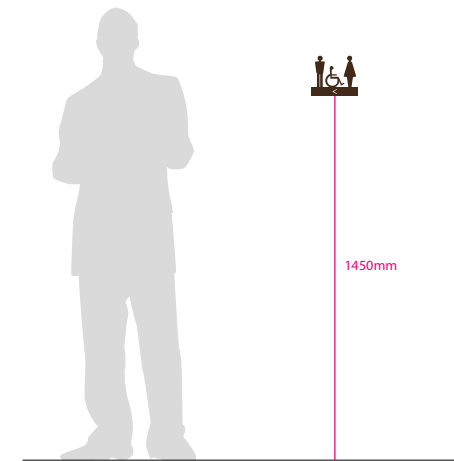
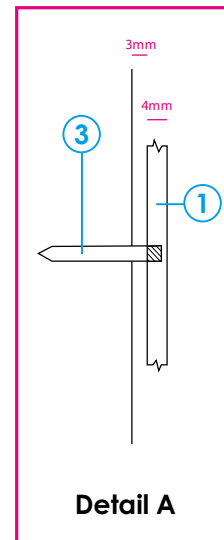

Restroom ID

Elevation

One piece 04mm uncoated bare brass, laser cut. Smoothed all edges.

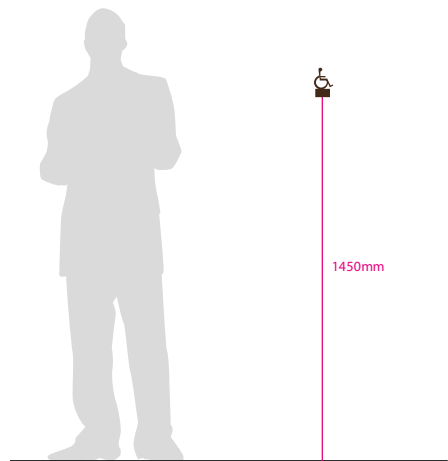
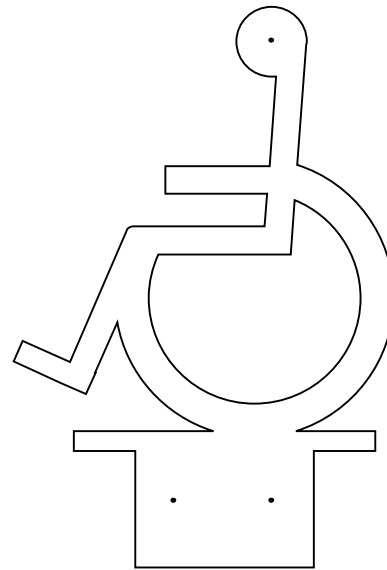
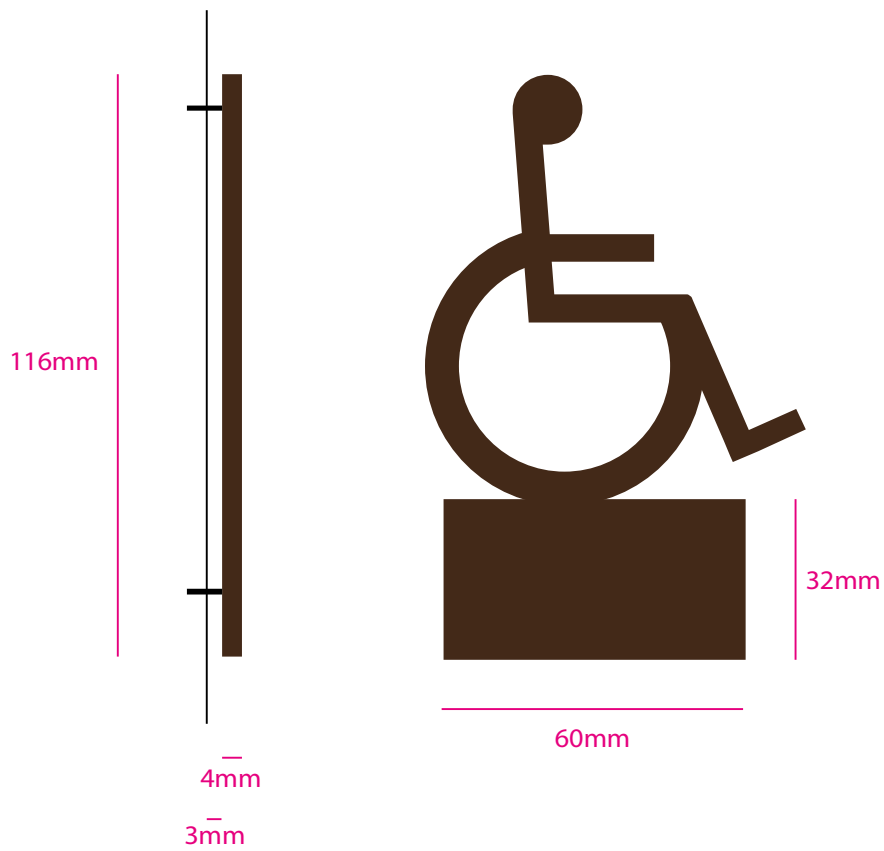

Restroom ID

Elevation

One piece 04mm uncoated bare brass, laser cut. Smoothed all edges.

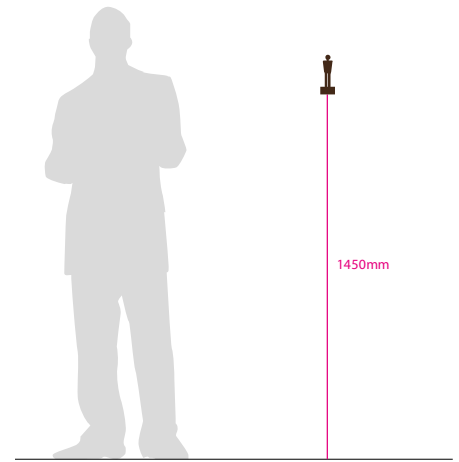
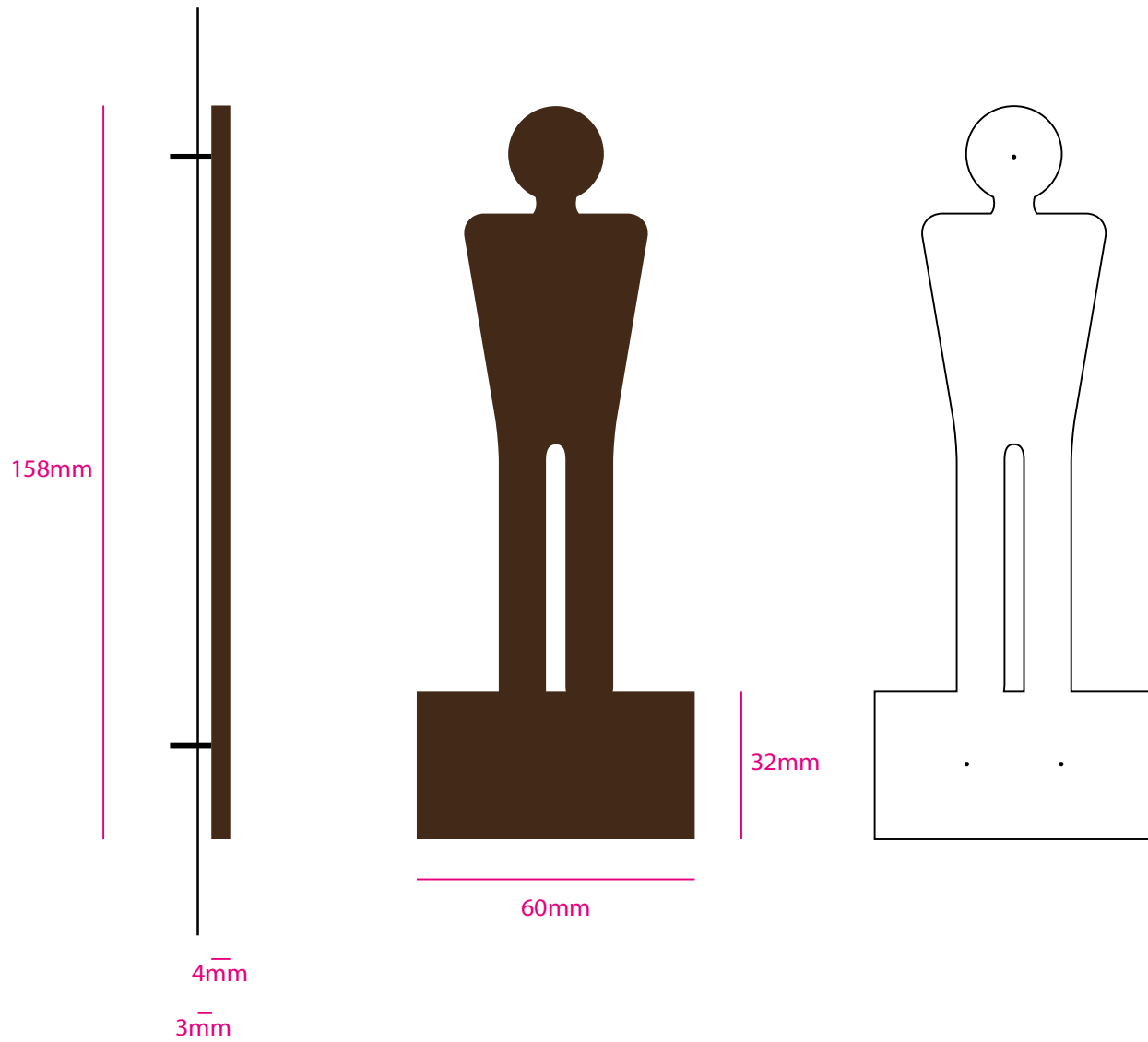

Restroom ID

Elevation

One piece 04mm uncoated bare brass, laser cut. Smoothed all edges.

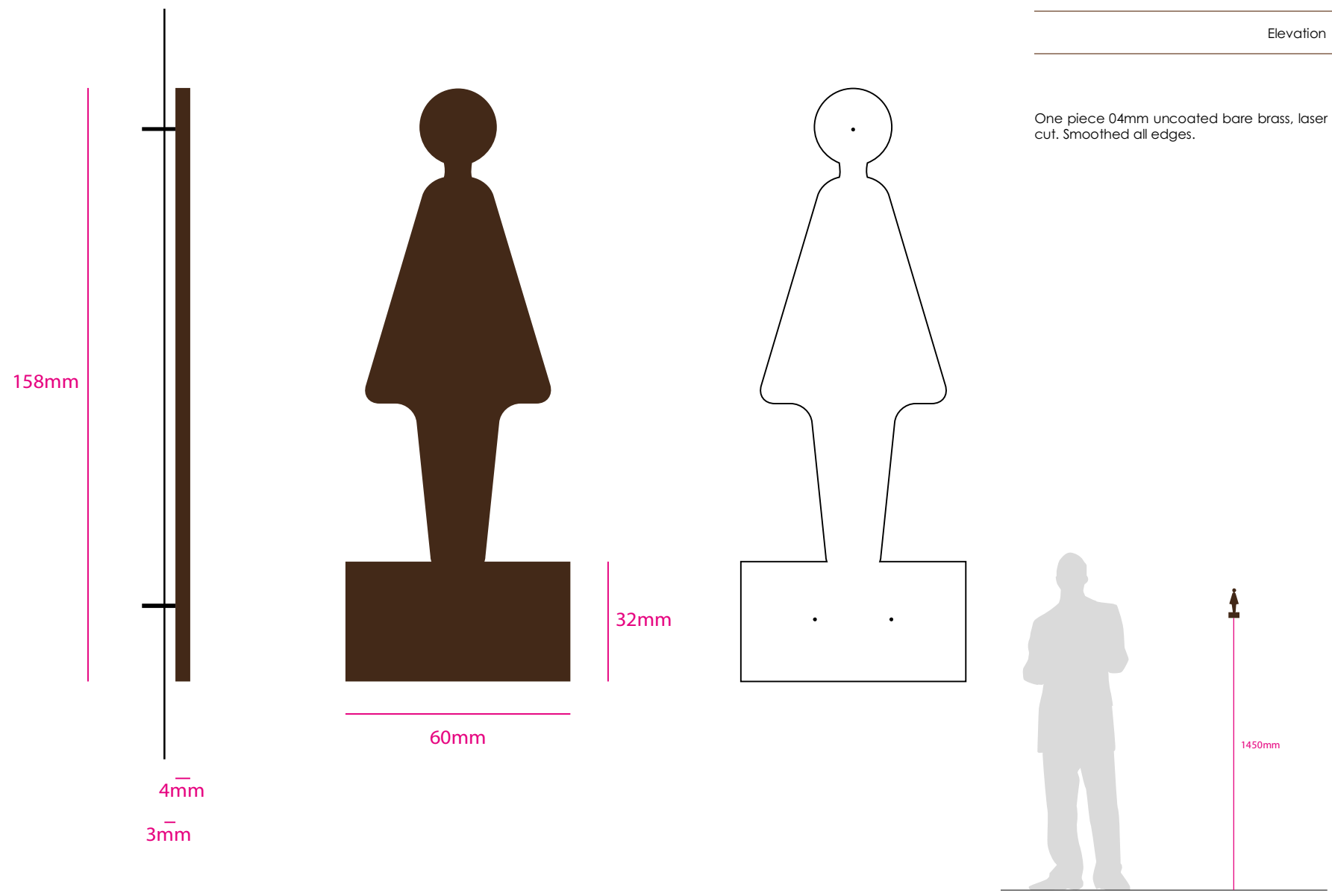

Facility ID

Render

BADMINTON

MAT A

PRIMARY MATERIAL PALETTE

Uncoated bare brass.

MAT Code	MAT Options
MAT A	Brass - Primary Stainless Steel - Secondary Powder Coated - Secondary

Facility ID

Elevation and Detail

- 1) Internal facility signs, laser cut from 04mm uncoated bare brass plate, left to naturally oxidize. Pin mounted off wall adjacent to facility door. Ireo crest etched in to front face, no infill.
- 2) 03mm solid brass locating/mounting pins screw taped into brass section 1. Liquid bonded into wall and granite section as required.
- 3) IREO crest etched to front face 01mm, no infill.

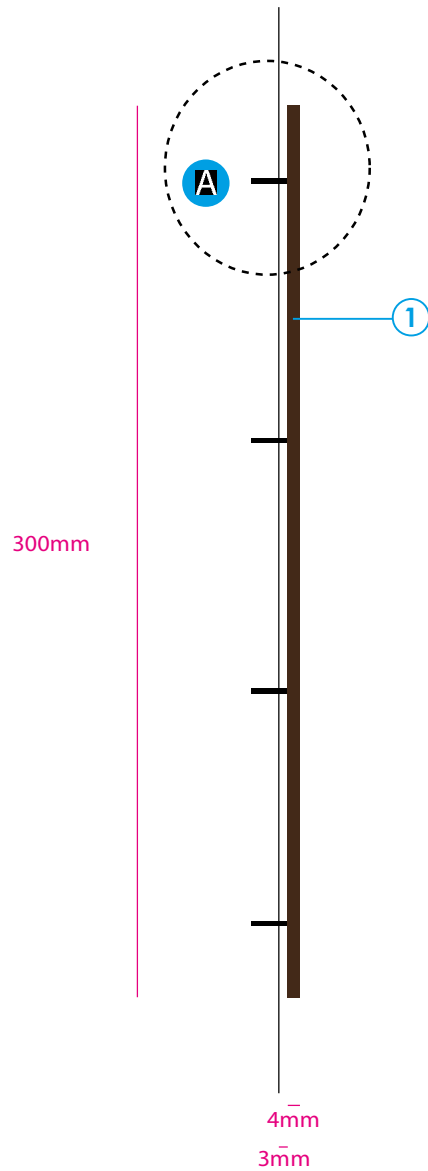

Side Elevation

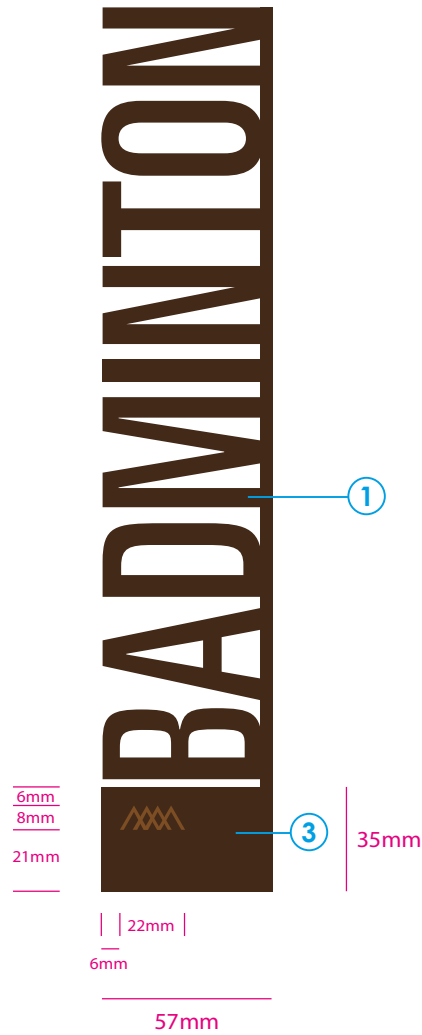

Front Elevation

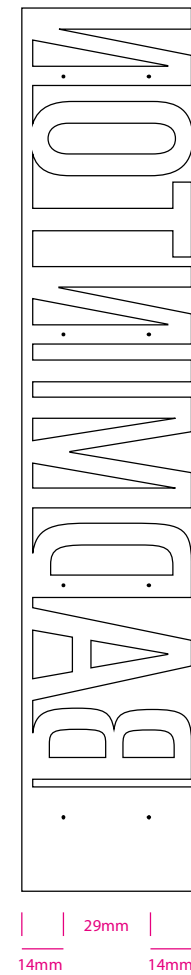

Reverse Face Mounting Pin Locations

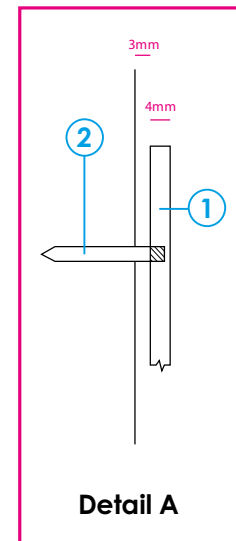

Detail A

Facility ID

Installation

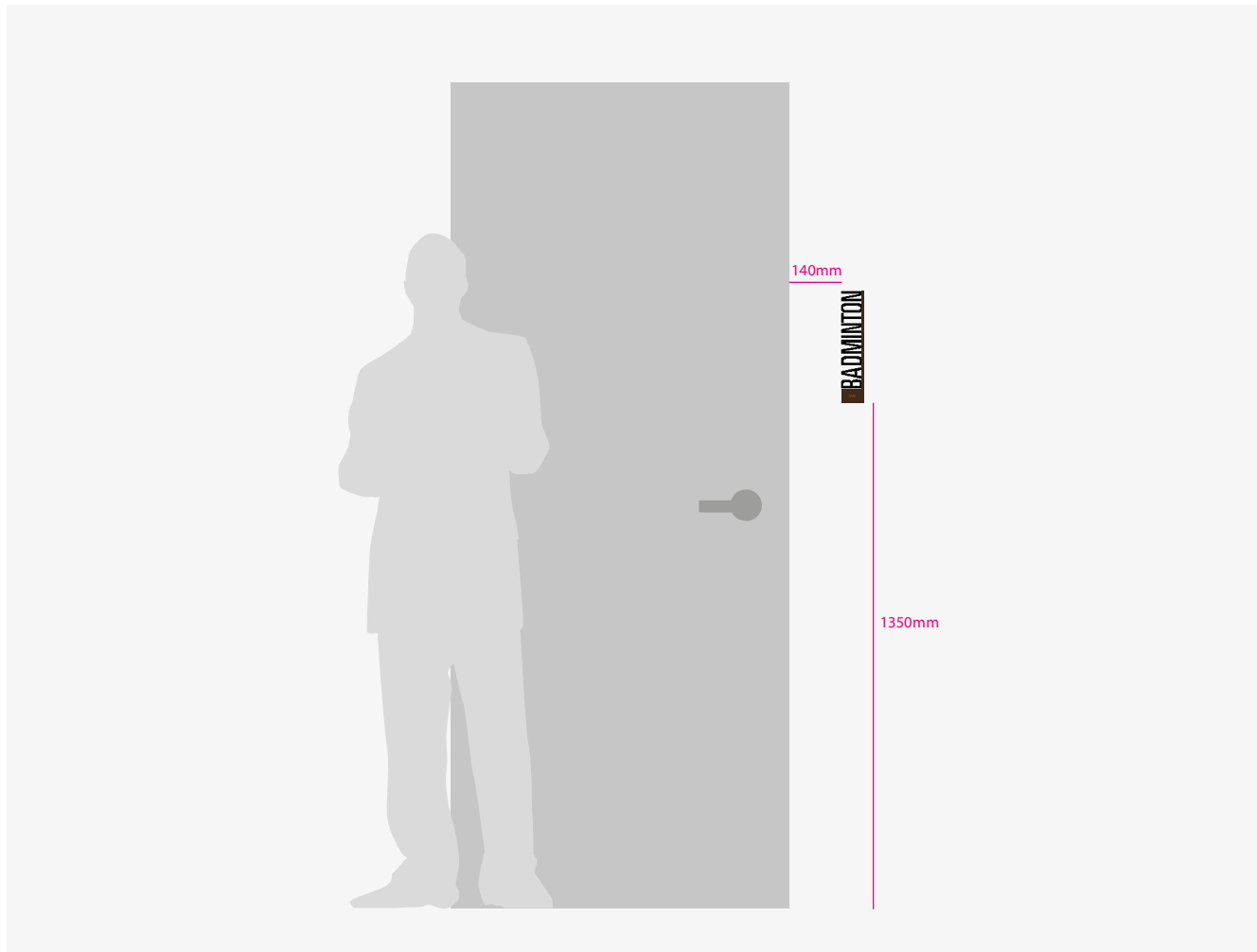

Facility ID

Typical Text Layout Example

BILLIARDS

BADMINTON

SOCIAL CLUB

SOAUSH

BANQUET 1

LIBRARY

BANQUET 2

GYMNASIUM

BAR

TABLE TENNIS

RESTAURANT

MASSAGE

BACK OF HOUSE

SECTION 9

Back of House ID

Elevation and Detail

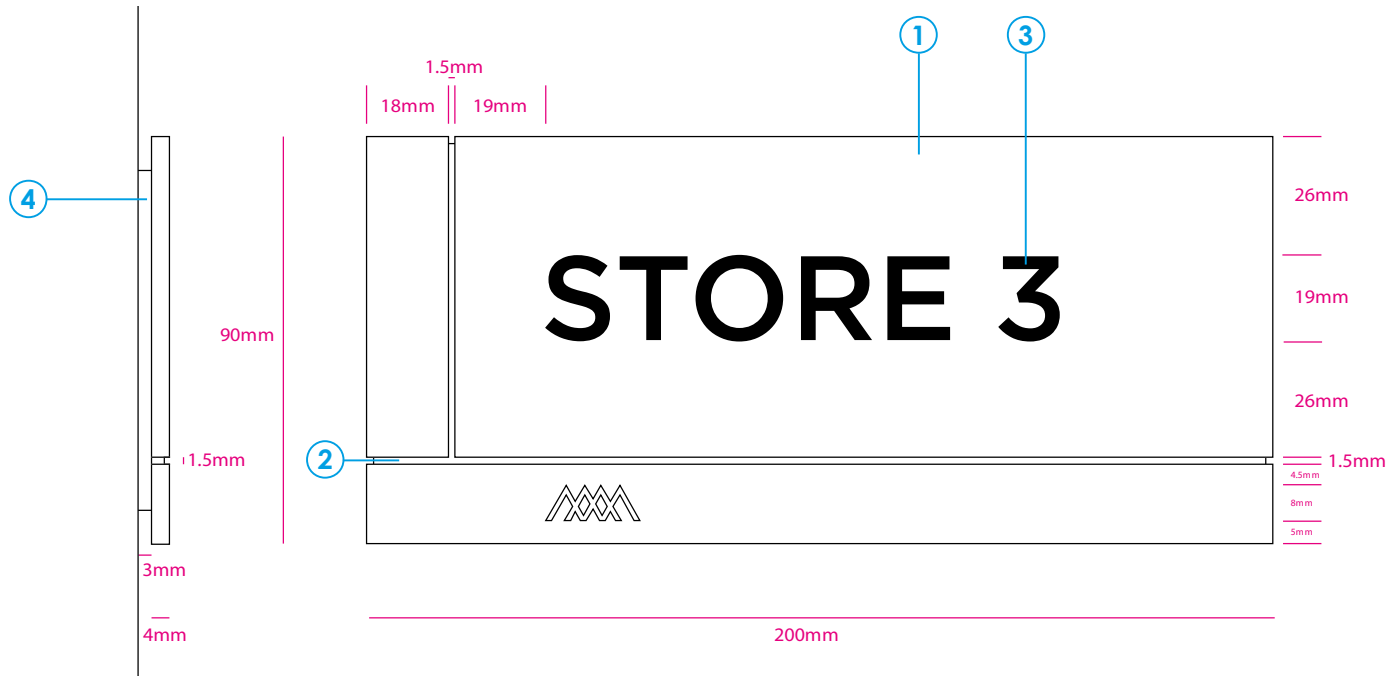

1) One piece 04mm clear acrylic, router cut. All edges flame finished.

2) Reveal surface routed 01mm. No infill.

3) Reverse face applied digital print. Text and graphic PMS 469 PC. background to colour match wall.

4) 03mm white acrylic backing spacer and fastening plate screw secured to wall. Front plate secured with adhesive tape and silicon bond. Centred on door face.

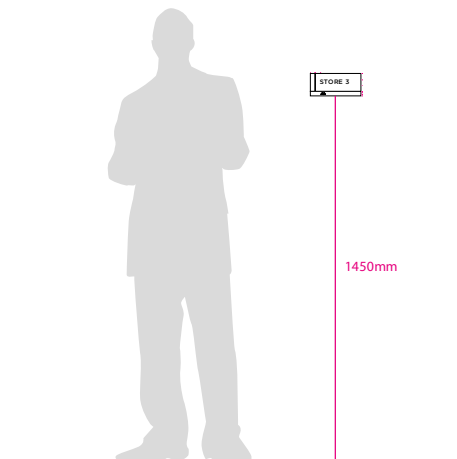

Internal Stairwell

Elevation and Detail

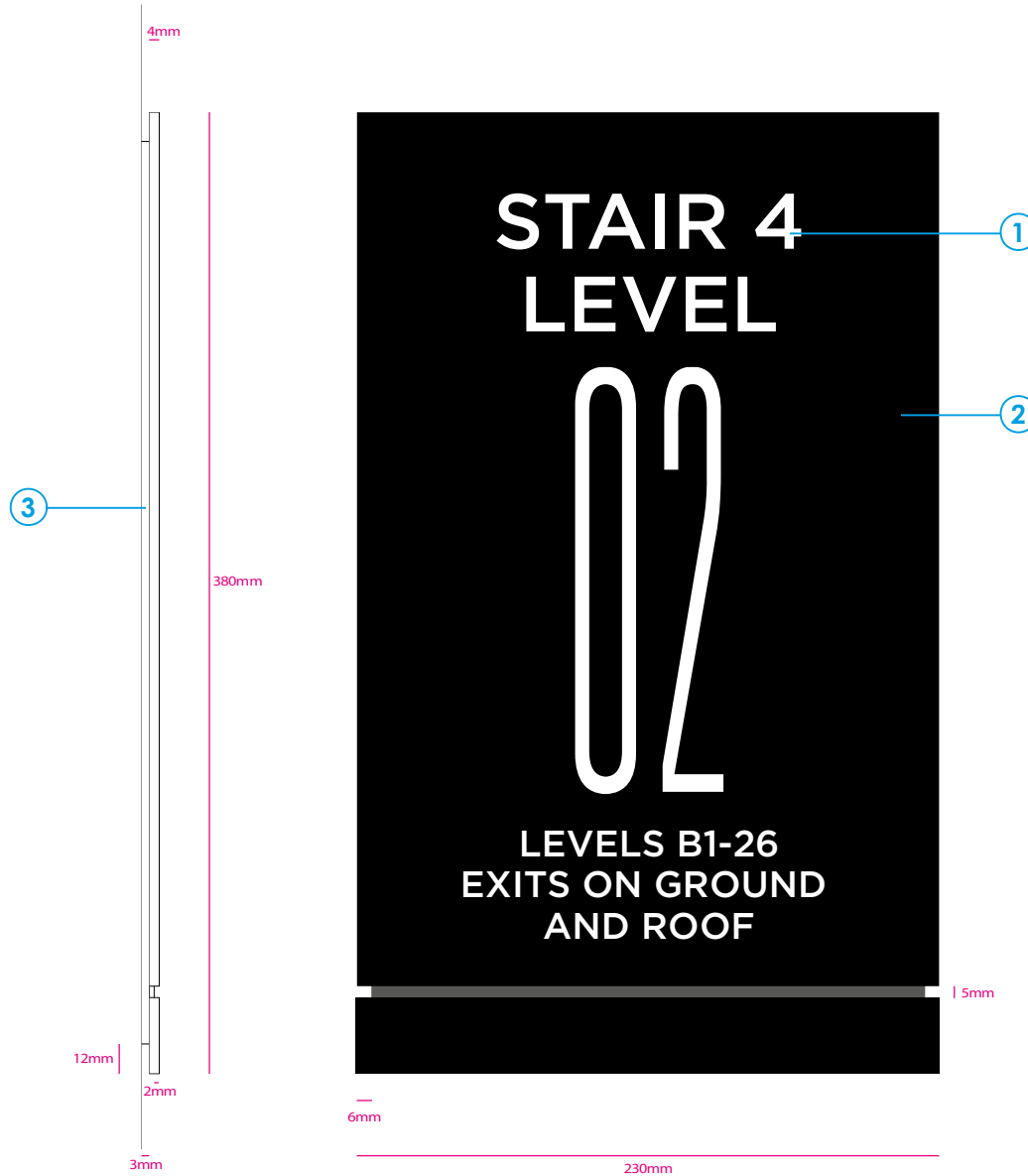

1) Text computer cut vinyl from white auto glow, adhesive vinyl.

2) 04mm matt black acrylic sign plaque flame finished edges. Tape and silicon bonded to back spacer - 3.

3) 03mm black acrylic back spacer. Screw fastened to wall.

